



Power Protector Stabilizer MFS Series

- Installation Guide -

The following document applies to PPS_MFS-i / -iR / -iF and PPS_MFS-L / -LR

1. Safety instructions

What this chapter contains

This chapter contains the safety instructions which you must follow when installing, operating and servicing the **Power Protector StabilizerMFS**. If ignored, physical injury or death may follow, or damage may occur to the **PPS MFS**. Read the safety instructions before you work on the unit.

Use of warnings and notes

There are two types of safety instructions throughout this manual: warnings and notes. Warnings caution you about conditions which can result in serious injury or death and/or damage to the equipment. They also tell you how to avoid the danger. Notes draw attention to a particular condition or fact, or give information on a subject. The warning symbols are used as follows:



Dangerous voltage warning warns of high voltage which can cause physical injury and/or damage to the equipment.



General warning warns about conditions, other than those caused by electricity, which can result in physical injury and/or damage to the equipment.



Electrostatic discharge warning warns of electrostatic discharge which can damage the equipment.



Hot surface warning warns of hot surfaces which can cause physical injury.

1.1. Installation and maintenance work

These warnings are intended for all who work on the PPSMFS, or cable.



WARNING! Ignoring the following instructions can cause physical injury or death, or damage to the equipment:

- Only qualified personnel are allowed to install and maintain the PPS MFS.
- PPS MFS is intended to be built into **commercial refrigeration appliances** or other **enclosures** that provide protection against certain external influences and, in any direction, protection against direct contact and electric shock.
- Never work on the PPSMFS or cable when main power is applied. Always ensure by measuring with a multimeter (impedance at least 1 Mohm) that voltage between device input phases INPUT and NEUTRAL is close to 0V.
- Do not work on the cables when power is applied to the device or to the external control circuits. Externally supplied control circuits may cause dangerous voltages inside the device even when the main power on the drive is switched off.
- Do not make any insulation or voltage withstand tests on the device.
- When reconnecting the wiring, always check that the phase order is correct.
- Do not change the electrical installations of the PPSMFS. Changes may affect the safety performance or operation of the device unexpectedly. All customer-made changes are on the customer's responsibility.

Note:

- The fast-on terminals on the device are at a dangerously high voltage when the input power is on.

1.2. Mechanical installation and maintenance

These instructions are intended for all who install and service the PPSMFS.



WARNING! Ignoring the following instructions can cause physical injury or death, or damage to the equipment:

- Handle the unit carefully.
- It shall be installed in an area where it is inaccessible without disassembly of the enclosing area.
- The **PPS MFS** made of two parts, the **Electronic Control Unit - ECU** - and the **Autotransformer - TRAF0**. None of these parts are serviceable or repairable.



• Beware of hot surfaces. Some parts, such as transformer, may remain hot for a while after disconnection of the electrical supply.

- Make sure that dust from borings and grindings does not enter the drive when installing. Electrically conductive dust inside the unit may cause damage or malfunctioning.
- Ensure for adequate cooling.
- Do not fasten the device by welding.

1.3. Printed circuit boards

WARNING! Ignoring the following instructions can cause damage to the printed circuit boards:



- The printed circuit boards contain components sensitive to electrostatic discharge. Wear a grounding wrist band when handling the boards. Do not touch the boards unnecessarily.

Operation

These warnings are intended for all who plan the operation of the drive or operate the drive.



WARNING! Ignoring the following instructions can cause physical injury or death, or damage to the equipment:

- Before powering the device check the wiring.

2. Mechanical installation

What this chapter contains

This chapter contains packing information and the mechanical installation instructions of the device.

2.1 Packing of the unit

The Electronic Control Unit- *ECU* - of the device is delivered in a cardboard box. The Autotransformer - *Trafo* - of the device is delivered in a cardboard box. The type, size and material of the package depend on the frame size of the Autotransformer.

2.2 Before installation

The device must be installed in an upright position (besidefigure) with allowance for adequate cooling. IP rating is met only when the ECU is installed in a vertical position with the connection tabs at the bottom. This is also important as the ECU also detects ambient temperature as one of its features.

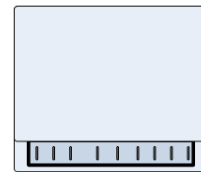

2.3 Dimensional drawings for the ECU (Electronic Control Unit) installation

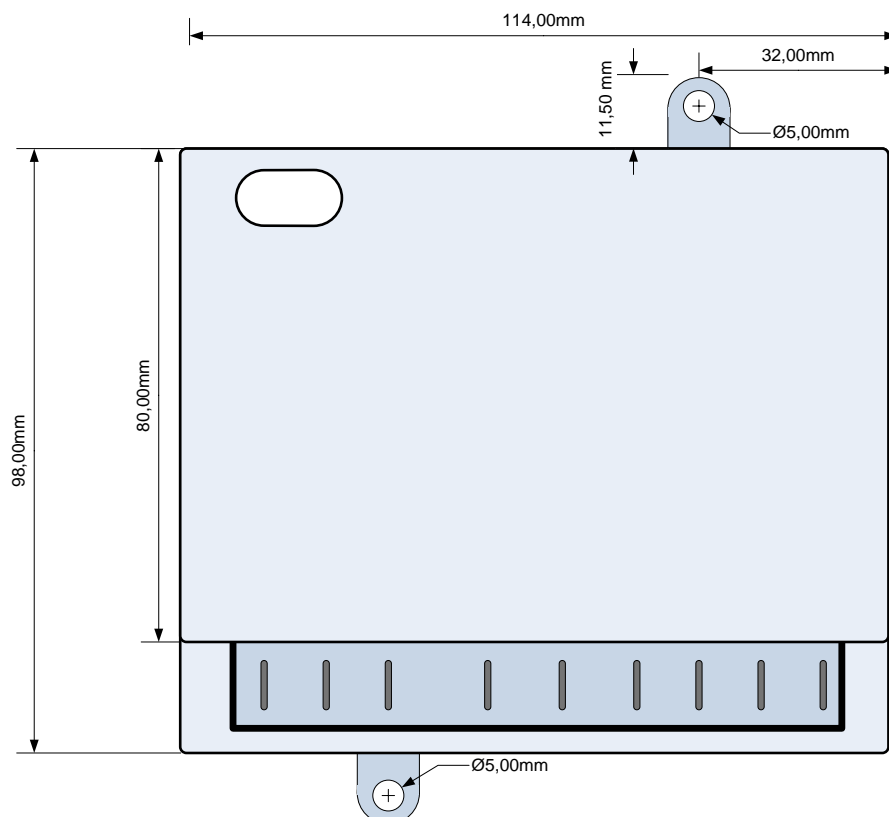

Top View

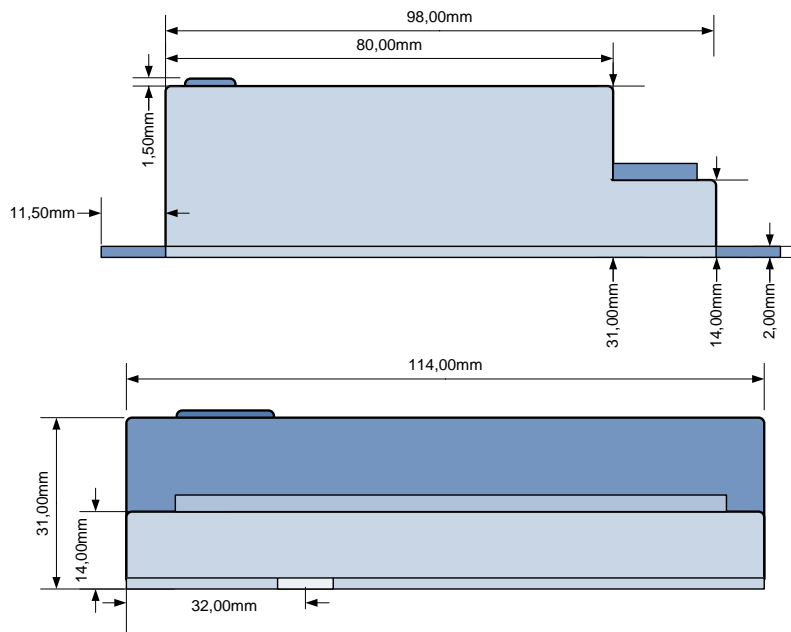

Side Views

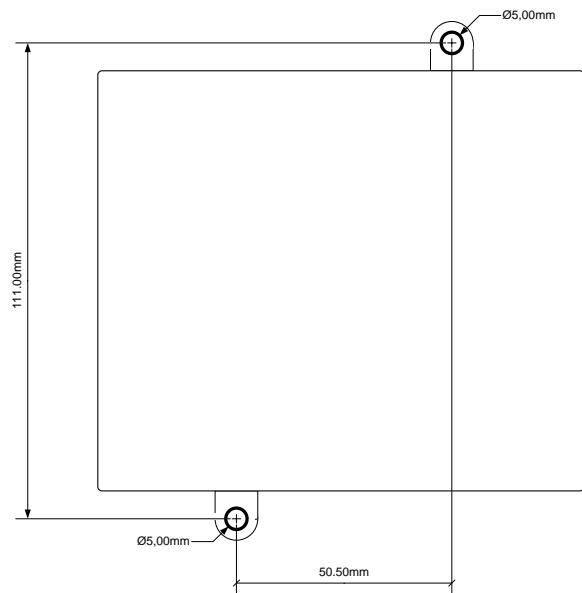

Holes for Screw

2.4 Dimensional drawings for Autotransformer.

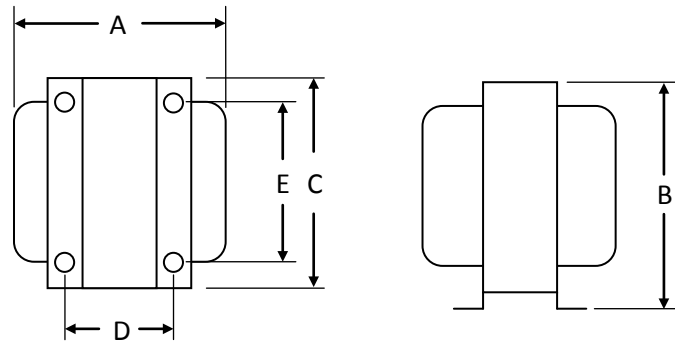

All dimensions are in mm.

Dimensions of Autotransformers are indicated below

| xxx : | 045 | 070 | 090 | 120 | 170 | 220 | 270 | |
|-----------------------|-----|-----|-----|-----|-----|-----|-----|-----|
| TrafoMFS-xxx i | A | 105 | 110 | 110 | 120 | 122 | 135 | 140 |
| | B | 75 | 75 | 86 | 86 | 94 | 105 | 105 |
| | C | 84 | 84 | 96 | 96 | 108 | 120 | 120 |
| | D | 50 | 55 | 55 | 65 | 68 | 72 | 77 |
| | E | 73 | 73 | 82 | 82 | 93 | 104 | 104 |

| xxx : | 045 | 070 | 090 | 120 | 170 | 220 | 270 | |
|------------------------|-----|-----|-----|-----|-----|-----|-----|-----|
| TrafoMFS-xxx iR | A | 110 | 120 | 130 | 140 | 132 | 140 | 150 |
| | B | 75 | 75 | 86 | 86 | 94 | 105 | 105 |
| | C | 84 | 84 | 96 | 96 | 108 | 120 | 120 |
| | D | 55 | 65 | 65 | 75 | 78 | 77 | 87 |
| | E | 73 | 73 | 82 | 82 | 93 | 104 | 104 |

| xxx : | 040L | 060L | 070L | 085L | 100L | 150L | 200L | |
|-----------------------|------|------|------|------|------|------|------|-----|
| TrafoMFS-xxx L | A | 106 | 116 | 120 | 127 | 133 | 138 | 150 |
| | B | 86 | 86 | 86 | 86 | 86 | 103 | 101 |
| | C | 96 | 96 | 96 | 96 | 96 | 120 | 115 |
| | D | 54 | 62 | 65 | 72 | 78 | 75 | 87 |
| | E | 82 | 82 | 82 | 82 | 82 | 104 | 105 |

| xxx : | 070 L | 085 L | 100 L | 150 L | 200 L | |
|------------------------|-------|-------|-------|-------|-------|-----|
| TrafoMFS-xxx LR | A | 130 | 137 | 143 | 147 | 160 |
| | B | 86 | 86 | 86 | 101 | 101 |
| | C | 96 | 96 | 96 | 115 | 115 |
| | D | 65 | 72 | 78 | 74 | 87 |
| | E | 82 | 82 | 82 | 100 | 100 |

3. Electrical installation

What this chapter contains

This chapter describes the electrical installation procedure of the drive.



WARNING! The work described in this chapter may only be carried out by a qualified electrician. Follow the Safety instructions on the first pages of this manual. Ignoring the safety instructions can cause injury or death. Make sure that the device is disconnected from the mains (input power) during installation.

3.1 Checking the insulation of the installation

Device

Do not make any insulation resistance tests on any part of the PPS MFS as testing can damage the device. The Autotransformer has been tested for insulation between the main circuit and the chassis at the factory. Moreover, the voltage limiting circuits incorporated in the PPS MFS will cut down the testing voltage automatically, during an insulation resistance test.

Supply cable

Check the insulation of the supply (input) cable according to local regulations before connecting to the drive.

PPS MFS is intended to be used with the protection of a fuse gG, type B, IEC60269-3-1.

Confirm compatibility with connection terminals as well as insulation. The connectors are Fast On terminals 6.3x0.8mm

3.2 Main Supply Connection Diagram

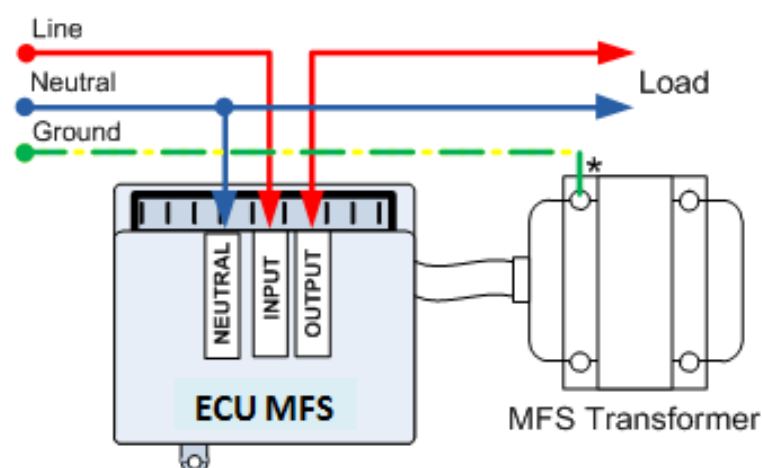

*: Detail of grounding Transformer Enclosure during implementation in the appliance from the installer:

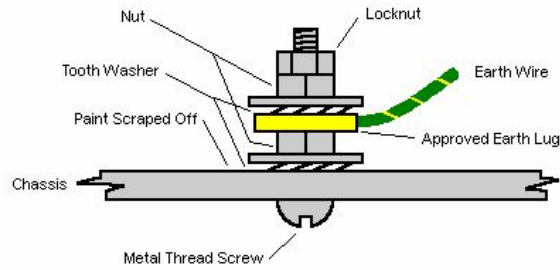

Care should be exercised from the installer to the following:

- The transformer hole and the screw used for Ground conductor connection must not be used for other reason (i.e. mechanical support etc.)
- Earth Conductor must be at least $2,5\text{mm}^2$ of the flexible stranded type. Should the conductor be more than 1 meter in length, earth resistance must be verified to be less than 0.1Ω .
- Earth connection must be realized near the point of the Incoming Protective earth (ground) of the appliance in which the PPS MFS is incorporated, marked with the symbol:

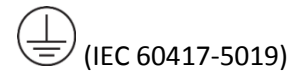

3.3 Connection between ECU and Autotransformer

The PPS MFS made of two parts, the Electronic Control Unit - *ECU* - and the Autotransformer - *TRAFO*.

The connection between ECU and Autotransformer must be made by using fast-on terminals. The length of the cable between ECU and Autotransformer can be 250mm, 550mm, 1000mm or 1200mm and depends on needs of customer.



WARNING! Ignoring the following instructions can cause damage to the equipment and/or violate design specifications.

PPS MFS is made up of non-repairable / refurbishable parts. In the event of a failure of the PPS MFS, both ECU and TRAFO have to be replaced with new unused units. Part replacement is not advisable.

Before powering the device:

- Confirm color coding between ECU and Autotransformer
- Confirm the correct fitting of the terminals to ensure IP rating of the connections.

4. Labeling

The PPS MFS made of two parts, the Electronic Control Unit - *ECU* - and the Autotransformer - *TRAFO*. Each of this parts has barcode, unless specified by the customer, the format of the information explained below.

4.1 ECU Barcode



VV : Version

xxxxxx : Item Barcode / Code (Thyratron SA):

YY WW : LOT Number (Y:Year W:Week)

ZZZZ : Counter of LOT

4.2 TRAF0 Barcode



xxxxx.xx : Internal Thyratron Code
 YY WW : LOT Number (Y:Year W:Week)
 ZZZZZ : Counter of LOT

4.3 Carton Barcode



[abc...] : Item Description
 YYWW : LOT Number (Y:Year W:Week)
 Qty : Units Quantity of Carton
 UOM : Units of measurement (pc: Pieces)
 pppppppppp : Purchase Order Number
 xxxxxx : Item Barcode / Code (Thyratron SA)
 ccccccccc : Item Barcode / Code (Customer)

Further Information

Support: rnd@thyratron.gr

Sales: sales@thyratron.gr

Site: www.thyratron.gr

Follow us at [linked in](#), [Facebook](#)

Address: KydoniesVasiliko, Erymanthos, Achaia, GR25008, GREECE

Tel: +30 26940 61868 Fax: +30 26940 62001